



**S D 14**

MONOBLOCK  
DIRECTIONAL CONTROL VALVES



## Features

Simple, compact designed, this valves is only one section for open centre and closed centre hydraulic systems.

- Fitted with a main pressure relief valve.
- Diameter 20 mm - 0.79 in interchangeable spools.
- Available manual, pneumatic, electro-hydraulic and remote with flexible cable spool control kits.

## Working conditions

This catalogue shows technical specifications and diagrams measured with mineral oil of 46 mm<sup>2</sup>/s - 46 cSt viscosity at 40°C temperature.

Nominal flow rating		120 l/min	
Operating pressure (maximum)		250 bar	3600 psi
Back pressure (maximum)	<i>on outlet port T</i>	25 bar	360 psi
Internal leakage A(B)→T	<i>Δp= 100 bar - 1450 psi fluid and valve at 40°C - 104°F</i>	3 cm <sup>3</sup> /min	0.18 in <sup>3</sup> /min
Fluid		Mineral base oil	
Fluid temperature	<i>with NBR (BUNA-N) seals</i>	from -20° to 80°C	
	<i>with FPM (VITON) seals</i>	from -20° to 100°C	
Viscosity	<i>operating range</i>	from 15 to 75 mm <sup>2</sup> /s	<i>from 15 to 75 cSt</i>
	<i>min</i>	12 mm <sup>2</sup> /s	12 cSt
	<i>max</i>	400 mm <sup>2</sup> /s	400 cSt
Max level of contamination		19/16 - ISO 4406	
Ambient temperature		from -40° to 60°C	

NOTE - For different conditions please contact Sales Dept.

### Additional information

This catalogue shows the product in the most usual configurations.  
Please contact Sales Dpt. for more detailed information or special request.

### WARNING!

All specifications of this catalogue refers to the standard product at this date. Walvoil, oriented to a continuous improvement, reserves the right to discontinue, modify or revise the specifications, without notice.

WALVOIL IS NOT RESPONSIBLE FOR ANY DAMAGE CAUSED BY AN  
INCORRECT USE OF THE PRODUCT.

7<sup>th</sup> edition October 2000:

This edition supercedes all prior documents.

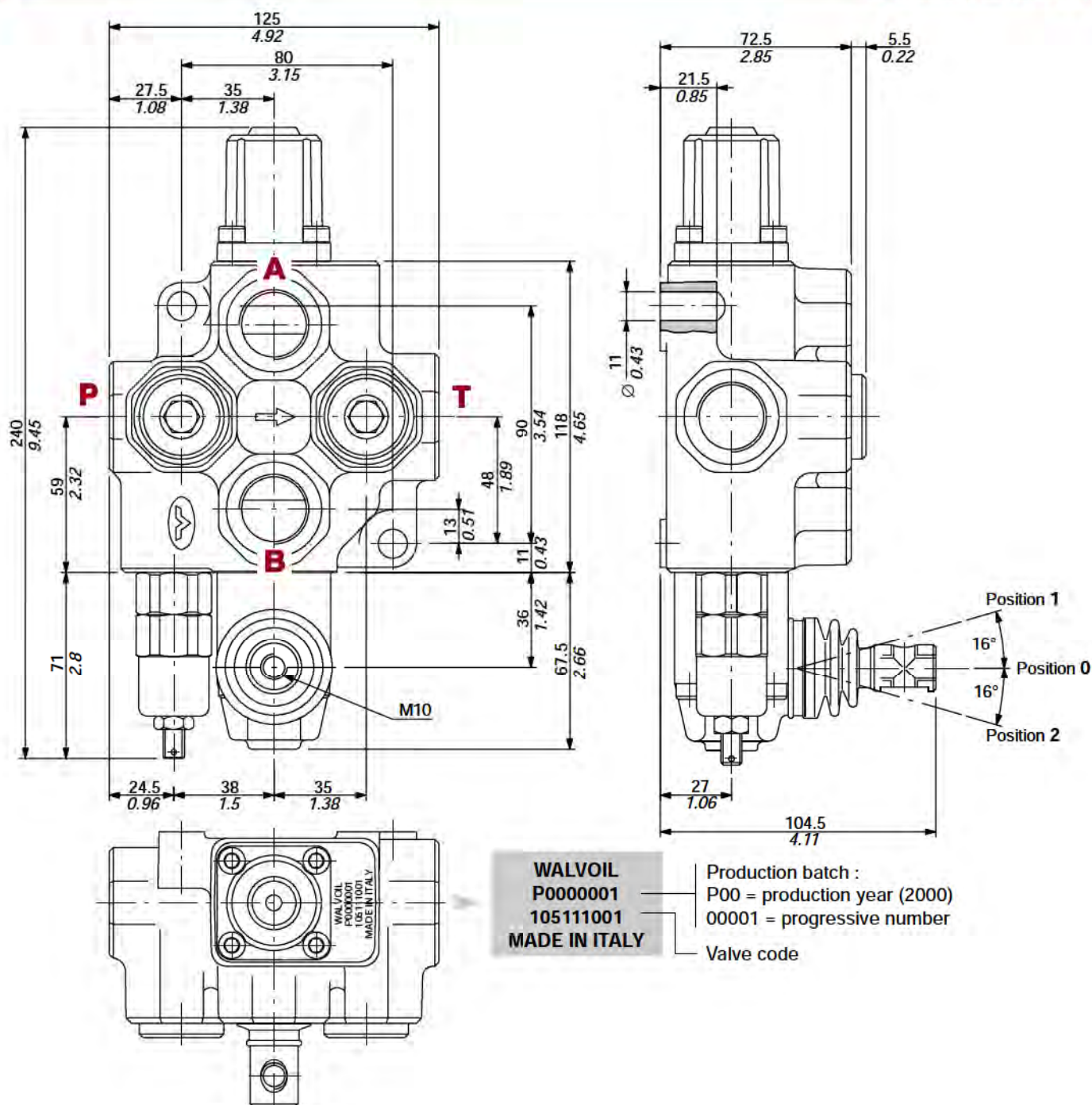

## Standard threads

PORT	BSP (ISO 228/1)	UN-UNF (ISO 11926-1)
Inlet P		
A and B ports	G 3/4	1 1/16-12 UN-2B (SAE 12)
Outlet T		
PILOT PORTS		
Pneumatic	NPTF 1/8-27	NPTF 1/8-27

# SD14

## Hydraulic circuit

Standard valve is supplied with positive overlap spool (1CP).

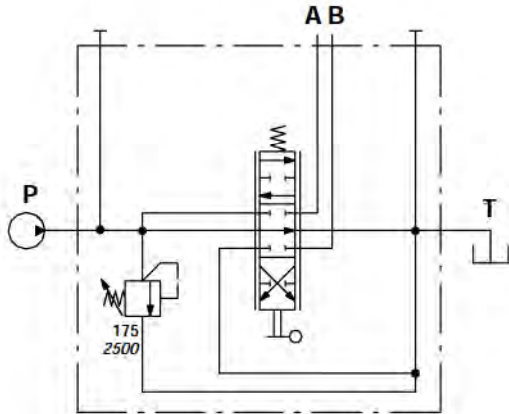

Ex.: SD14/1(YG3-175)/1CP8L

## Right inlet

A symmetrical body allows the reverse assembly of spool and relative control kit and lever (ED configuration).

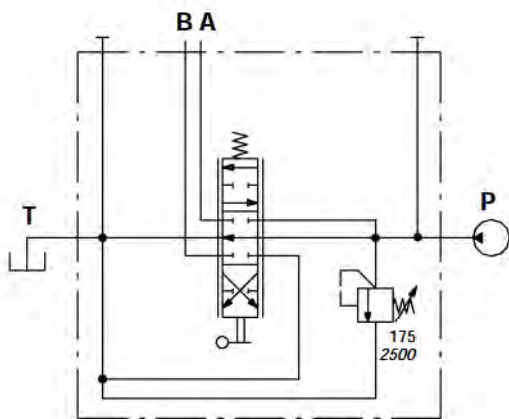

Ex.: SD14/1(YG3-175)/ED-1CP8L

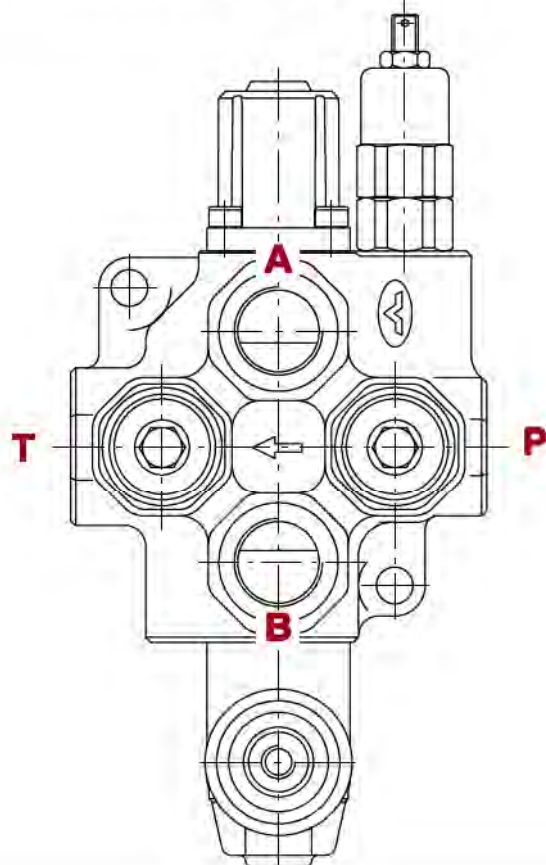

## Performance data (pressure drop vs. flow)

## Open centre

From inlet to outlet.

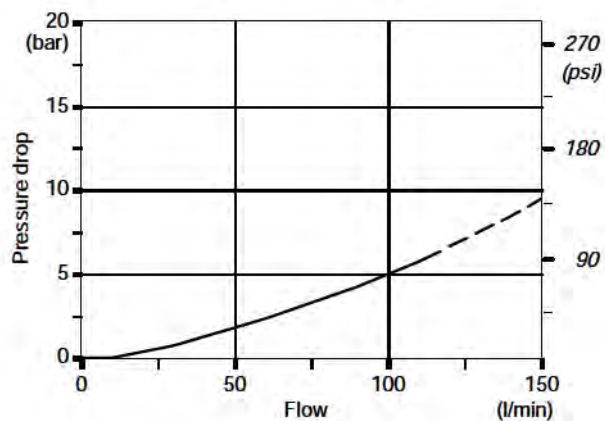
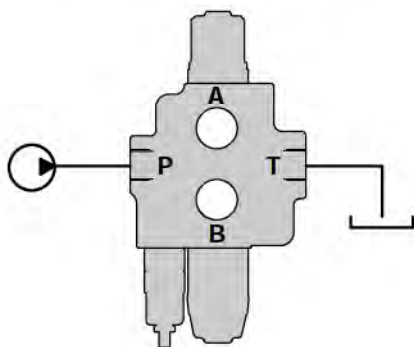

## Inlet to work port

From inlet to A port (spool in position 1) or B port (spool in position 2).

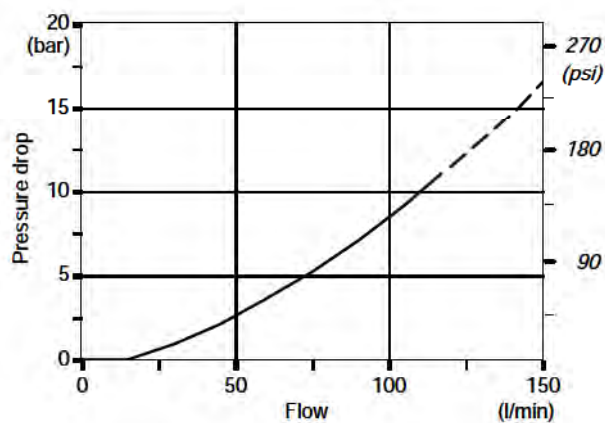
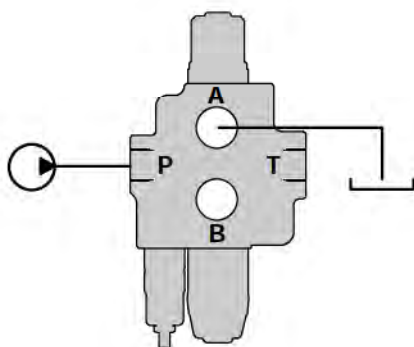

## Work port to outlet

From A port (spool in position 2) or B port (spool in position 1) to outlet.

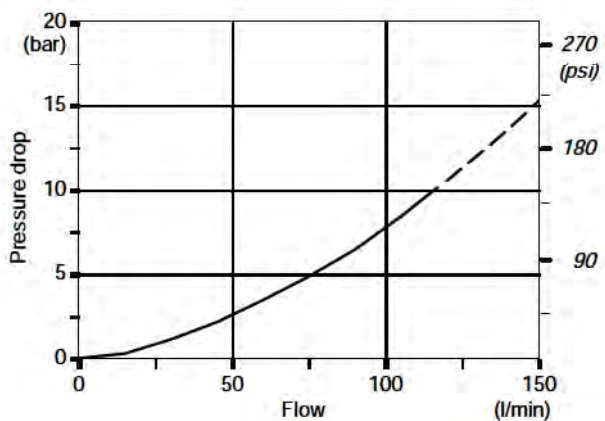
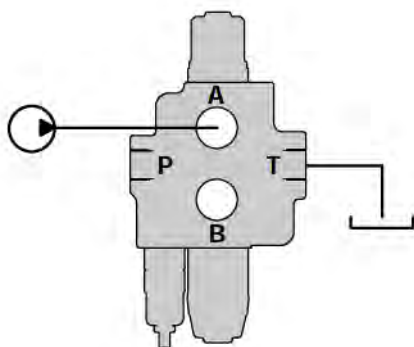

NOTE - Measured with spool type 1CP.

# SD14

## Ordering codes

### Description example:

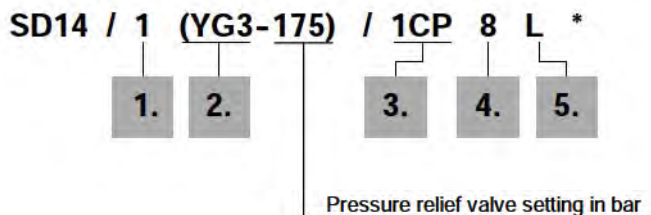

### 1. Body kits \*

TYPE	CODE	DESCRIPTION
1	5KC1603040	1 section

Include body, seals and rings.

### 2. Inlet relief options

TYPE	CODE	DESCRIPTION
<u>VMD10/1 direct pressure relief valve type Y</u>		
(YG2-125)	3XCAR110212	Range 80 to 160 bar / 1150 to 2300 psi standard setting 125 bar / 1800 psi
(YG3-175)	3XCAR110213	Range 125 to 250 bar / 1800 to 3600 psi standard setting 175 bar / 2500 psi
(YG4-220)	3XCAR110214	Range 200 to 315 bar / 2900 to 4600 psi standard setting 220 bar / 3200 psi

#### VMP10/1 pilot operated pressure relief valve type X

(XG-125)	X006211120	Range 25 to 315 bar / 360 to 4600 psi standard setting 125 bar / 1800 psi
----------	------------	--

Standard setting is referred to 10 l/min flow.

SV	XTAP526340	Relief valve blanking plug
----	------------	----------------------------

### 3. Spool options

TYPE	CODE	CIRCUIT DESCRIPTION
1CP	3CU1510140	Double acting with positive overlap, 3 positions, A and B closed in neutral position
1N	3CU1510100	Double acting, 3 positions, A and B closed in neutral position
2	3CU1525600	Double acting, 3 positions, with A and B open to tank in neutral position
3CP	3CU1531140	Single acting on A, 3 positions, B plugged requires G3/4 plug (see part I)
4CP	3CU1535140	Single acting on B, 3 positions, A plugged requires G3/4 plug (see part I)
6	3CU1550100	Double acting, 3 positions, closed center
7	3CU1555100	Double acting, 3 positions, closed center with A and B to tank in neutral position

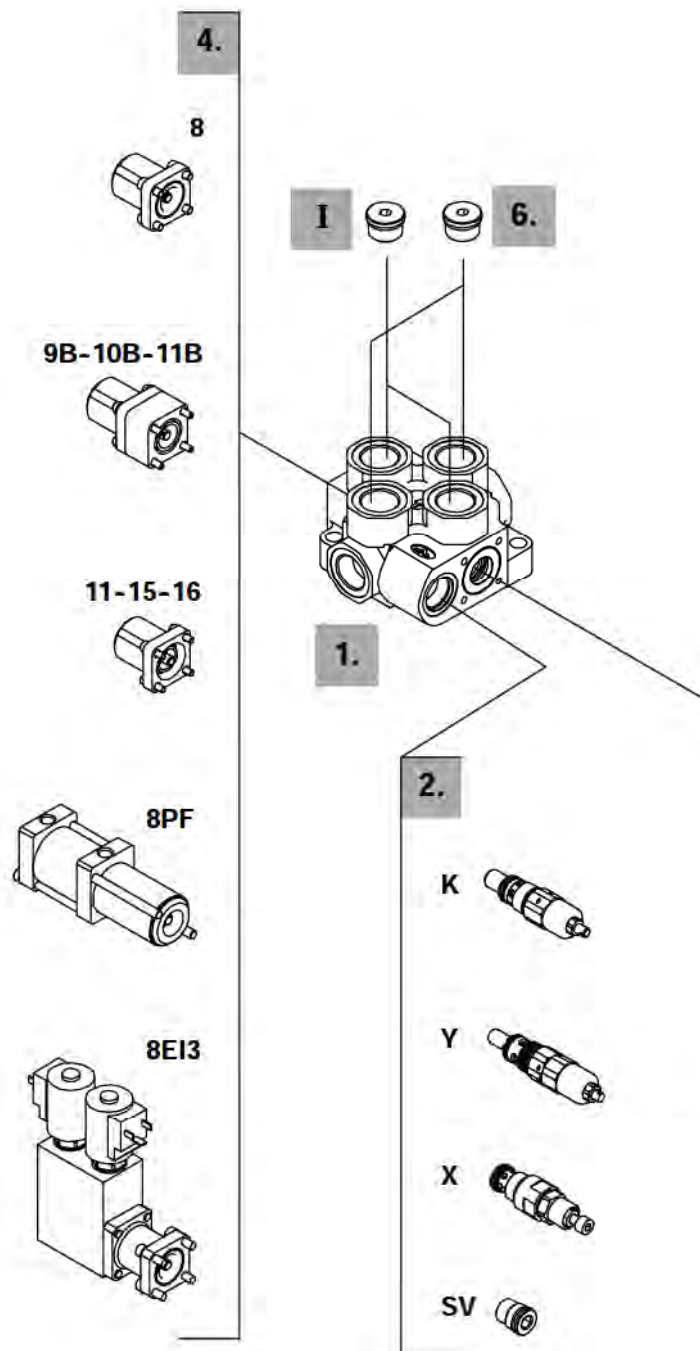

NOTE (\*) - Items are referred to BSP thread.

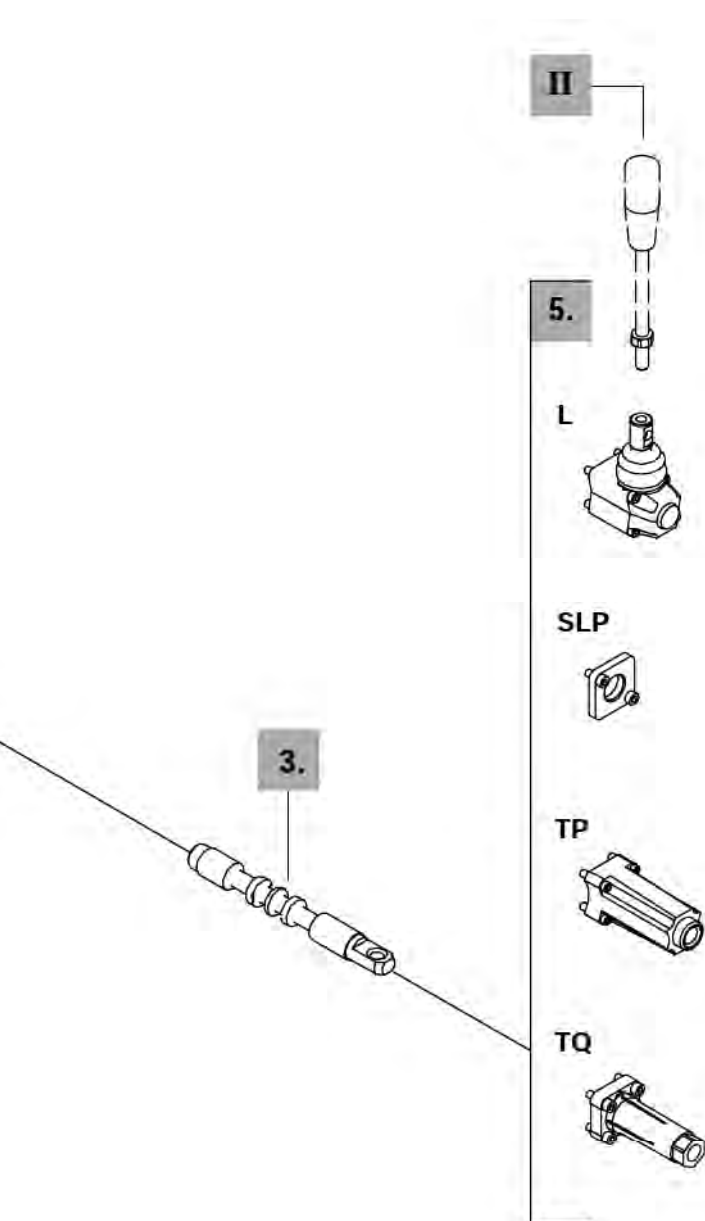

#### 4. "A" side spool positioners

TYPE	CODE	DESCRIPTION
8	5V08110000	With spring return in neutral position
9B	5V09110000	With detent in position 1 and spring return in neutral position
10B	5V09110000	With detent in position 2 and spring return in neutral position
11	5V11110000	With detent in position 1, neutral and 2
11B	5V11210000	With detent in position 1 and 2, spring return in neutral position
15	5V15110000	With detent in position 1 and neutral
16	5V16110000	With detent in position 2 and neutral
8PF	5V08110705	Proportional pneumatic kit
8E13	5V08110350	12 VDC ON/OFF electro-hydraulic kit
	5V08110351	24 VDC ON/OFF electro-hydraulic kit

#### 5. "B" side handle options

TYPE	CODE	DESCRIPTION
L	5LEV110000	Standard lever box
SLP	5COP110000	Without lever, with dust proof plate
TP	5TEL110005	CG cable connection
TQ	5TEL110110	CD cable connection

#### 6. Inlet and outlet selection \*

TYPE	CODE	DESCRIPTION
PSL	3XTAP732200	G3/4 plug for side inlet and outlet (nr.2 plugs required). Standard configuration; "PSL" must be omitted
PSA	3XTAP732200	G3/4 plug for upper inlet and outlet (nr.2 plug required)

#### I Port plug \*

TYPE	CODE	DESCRIPTION
G3/4	3XTAP732200	Plug for single acting spool

#### II Optional handlevers

TYPE	CODE	DESCRIPTION
AL01/M10x200	170012020	Lenght L = 200mm / 7.87in

For special configurations see pages 9 and 10

## Spools options

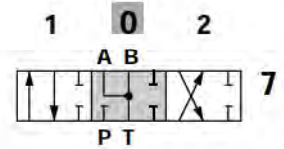
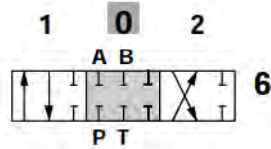
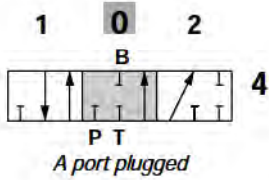
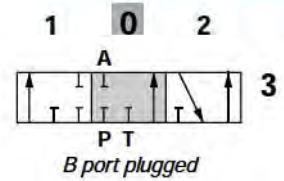
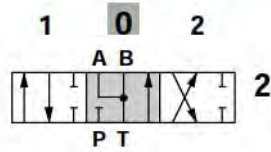
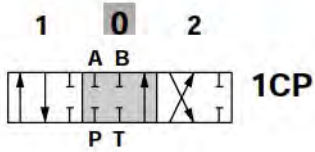

## "A" side spool positioners

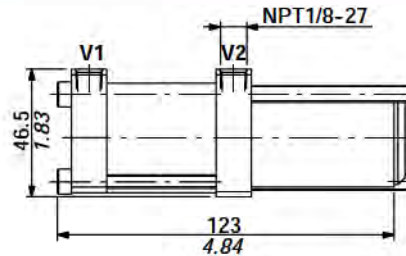
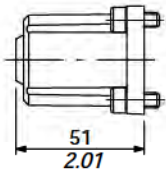

### Operating features

Adjustment range : from 2 to 6.5 bar  
(29 to 94 psi)  
diagram 501A  
Max.pilot pressure : 10 bar (145 psi)

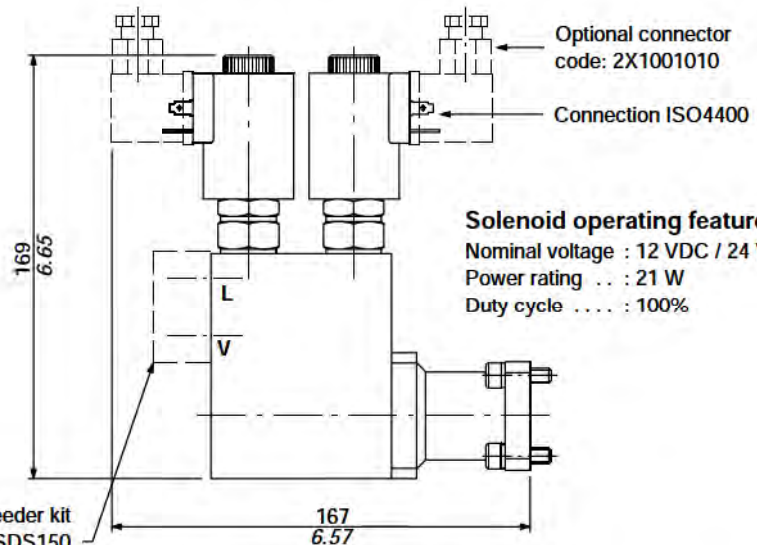
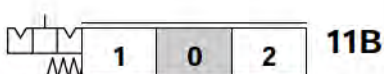
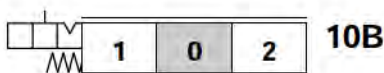
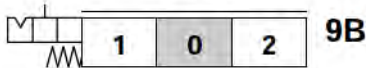
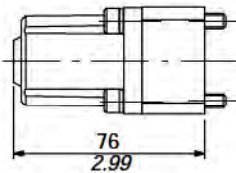
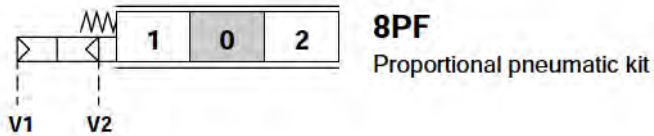
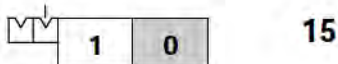
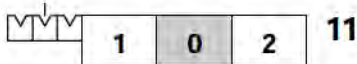
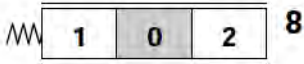

### Solenoid operating features

Nominal voltage : 12 VDC / 24 VDC  
Power rating ... : 21 W  
Duty cycle ... : 100%

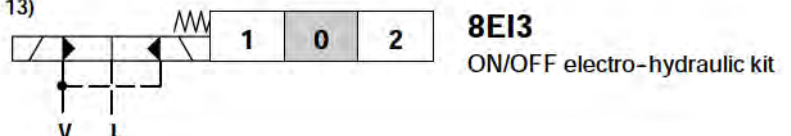

Directional valve with rotary control kit

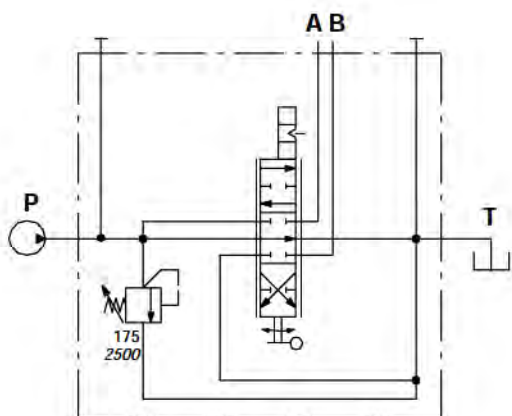
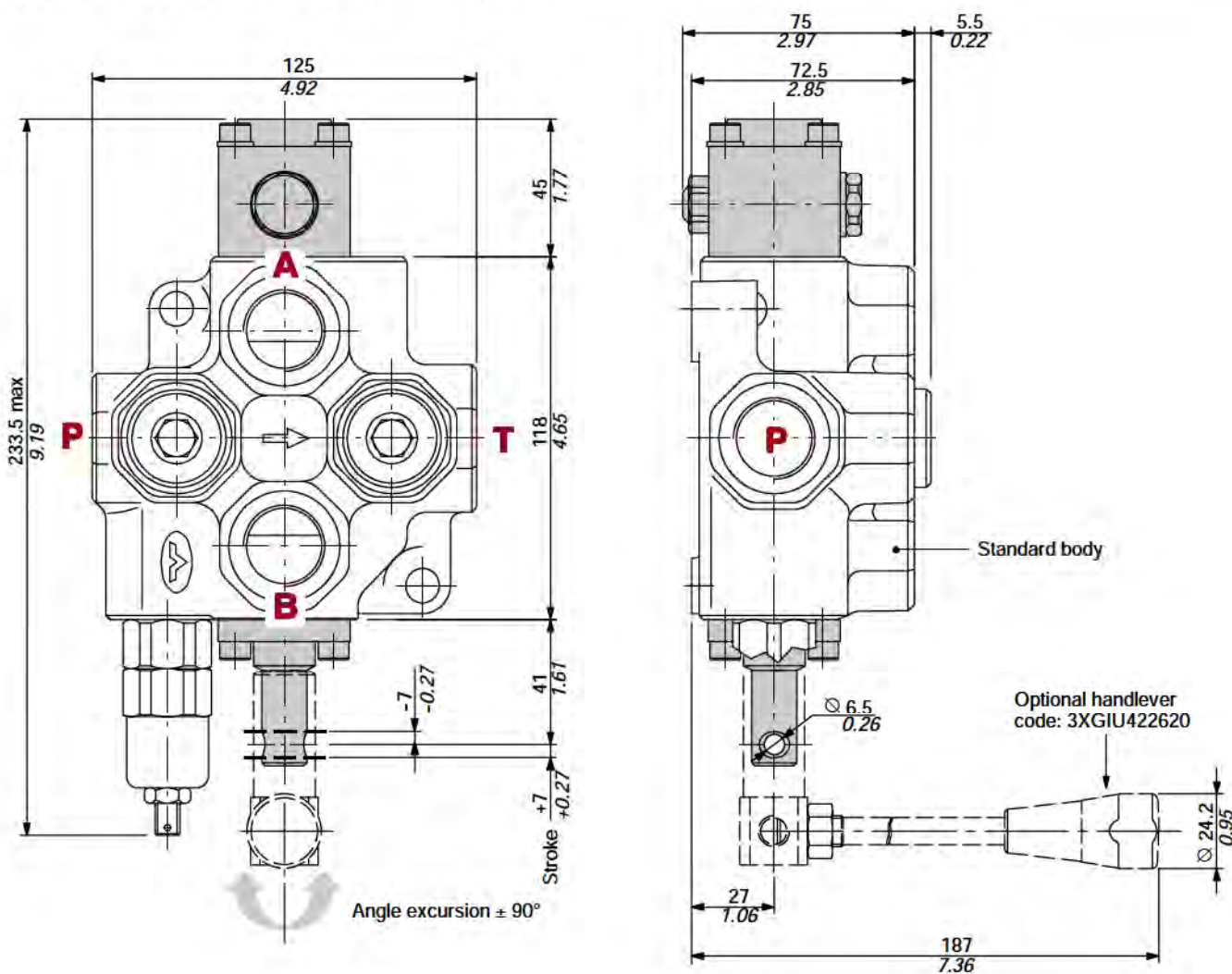

Ex.: SD14/1(YG3-175)/ 1N R SLP

- Dust proof plate kit: code 5COP110000
- Rotary positioner kit: code 5ROT110000
- Spool: code 3CU1510561 (egative overlap)



## Installation and maintenance

The SD14 valve is assembled and tested as per the technical specification of this catalogue.

Before the final installation on your equipment, follow the below recommendations:

- the valve can be assembled in any position, in order to prevent body deformation and spool sticking mount the product on a flat surface;
- in order to prevent the possibility of water entering the lever box and spool control kit, do not use high pressure wash down directly on the valve;
- prior to painting, ensure plastic port plugs are tightly in place.

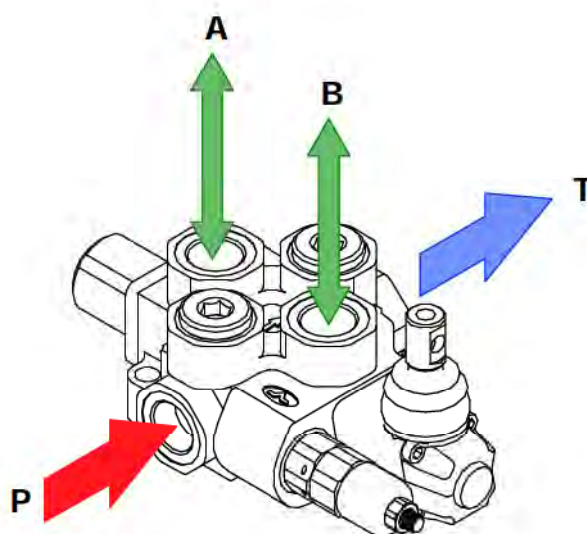

### Fitting tightening torque - Nm / lbft

THREADS TYPE	All ports
BSP (ISO 228/1)	G 3/4
With O-Ring seal	90 / 66.4
With copper washer	60 / 44.3
With steel and rubber washer	70 / 51.6
UN-UNF (ISO 11926-1)	1 1/16-12 UN-2B (SAE 12)
With O-Ring seal	95 / 70

NOTE - These torque are recommended. Assembly tightening torque depends on many factors, including lubrication, coating and surface finish. The manufacturer shall be consulted.



WALVOIL S.P.A.

42100 REGGIO EMILIA • ITALY • VIA ADIGE, 13/D  
TEL. +39.0522.932411 • FAX +39.0522.300984  
E-MAIL: INFO@WALVOIL.COM • HTTP: //WWW.WALVOIL.COM

SALES DEPARTMENT

TEL. +39.0522.932555 • FAX +39.0522.932455

DAC005E