



EE..A type

directional solenoid valves - 2 ways / 2 positions

- Direct acting
- Spool type
- Normally open and closed configurations
- From SAE08 to SAE12 cavities

Technical specifications and diagrams are measured with mineral oil of 46 cSt viscosity at 40°C (104°F) temperature.

	EE08A	EE10A	EE12A
Nominal flow	8 l/min (2.11 US gpm)	30 l/min (7.9 US gpm)	40 l/min (10.5 US gpm)
Max. pressure	210 bar (3050 psi)		
Oil leakage	at 210 bar (3050 psi) 30 cm ³ /min (1.83 in ³ /min)	55 cm ³ /min (3.35 in ³ /min)	75 cm ³ /min (4.58 in ³ /min)
Fluid	mineral based oil		
Viscosity	10-200 cSt		
Max level of contamination	18/16/13 ISO4406		
Fluid temperature	with NBR seals with FPM seals	from -20°C (-4°F) to 80°C (176°F) from -20°C (-4°F) to 100°C (212°F)	
Environmental temp. for working conditions	from -20°C (-4°F) to 50°C (122°F)		
Cavity	SAE 8/2	SAE 10/2	SAE 12/2
Coil type*	BER	BIN 19	BIN 22
Nominal voltages	12 VDC - 24 VDC ± 10%		
Power rating	22.8 W (12 VDC) 22.5 W (24 VDC)	29 W (12 VDC) 31 W (24 VDC)	32.6 W (12 VDC) 31 W (24 VDC)
Weight	0.18 kg (0.40 lb)	0.28 kg (0.64 lb)	0.44 kg (0.97 lb)

NOTE - For different conditions, please contact Walvoil Sales Dpt. - *For coils further features see from page 190.

Normally open configuration

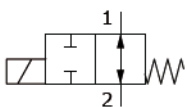

Normally closed configuration

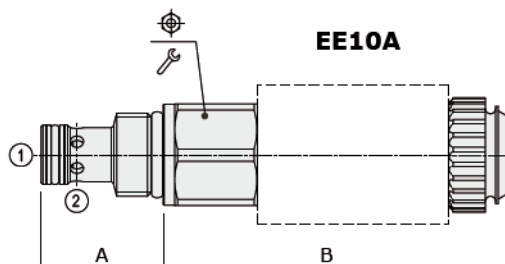
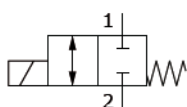

Valve type	A		B				Nm	lbft
	mm	in	mm	in				
EE08A/	10NB	27.6	1.09	76	2.99	24	30	22
	20NB	27.6	1.09	76	2.99	24	30	22
EE10A/	10PB	32.3	1.27	90.3	3.56	27	50	37
	20PB	32.3	1.27	90.3	3.56	27	50	37
EE12A/	10PB	46	1.81	102	4.02	32	80	59
	20PB	46	1.81	90.3	3.56	32	80	59

Ordering codes and description composition

EE08A/10 NB

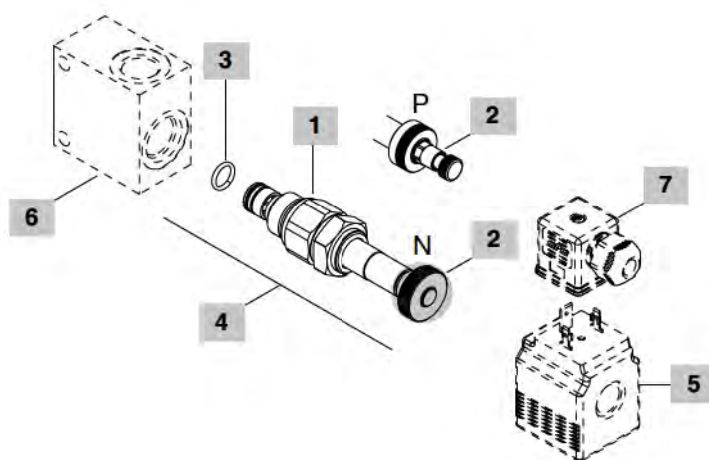
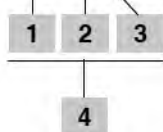

1 Spool

TYPE	DESCRIPTION
1	Normally open configuration
2	Normally closed configuration

2 Emergency

TYPE	DESCRIPTION
N	Without emergency only for 8/2
P	Push button type only for 10/2 and 12/2

Note: for configurations with different emergency contact Sales Dept.

3 Seals

TYPE	DESCRIPTION
B	NBR (Buna) o-ring seals, std configuration
V	FPM (Viton) o-ring seals, contact Sales Dept.

4 Cartridges

TYPE	CODE	DESCRIPTION
SAE cavity 8/2		
EE08A/10NB	0EE08002001	Normally open configuration (N.O.) without emergency
EE08A/20NB	0EE08002000	Normally closed configuration (N.C.) without emergency
SAE cavity 10/2		
EE10A/10PB	0EE10002003	Normally open configuration (N.O.) with push-button emergency
EE10A/20PB	0EE10002002	Normally closed configuration (N.C.) with push-button emergency
SAE cavity 12/2		
EE12A/10PB	0EE12002005	Normally open configuration (N.O.) with push-button emergency
EE12A/20PB	0EE12002004	Normally closed configuration (N.C.) with push-button emergency

5 Coils

TYPE	CODE	DESCRIPTION
BER 12 VDC	4SLE001200	12VDC-ISO4400 coil for EE08A
BIN 19 VDC	4SL6000121	12VDC-ISO4400 coil for EE10A
BIN 22 VDC	4SL6000128	12VDC-ISO4400 coil for EE12A

For complete coils list see from page 190

6 Valve body

TYPE	CODE	DESCRIPTION
SAE 08/2-G 3/8	3CC0820C11	Aluminium body for cavity 08 valve, G3/8 std thread
SAE 10/2-G 3/8	3CC1020C11	Aluminium body for cavity 08 valve, G3/8 std thread
SAE 12/2-G 1/2	3CC1220D11	Aluminium body for cavity 12 valve, G1/2 std thread

For steel bodies or different threading see from page 199

7 Connector

TYPE	CODE	DESCRIPTION
ISO4400	4CN1009995	Connector

For complete connectors list see from page 190

Rating diagrams

EE08A pressure drop vs. flow
- Spool 1 -

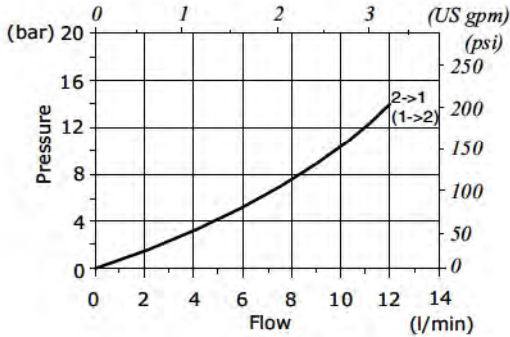

EE08A pressure drop vs. flow
- Spool 2 -

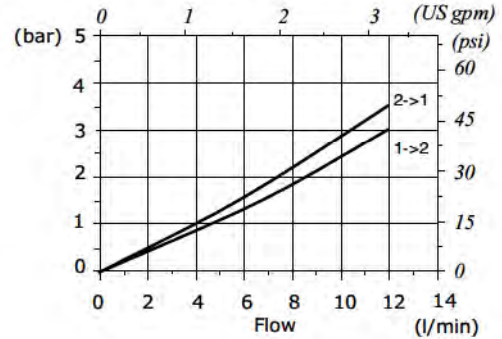

EE10A pressure drop vs. flow
- Spool 1 -

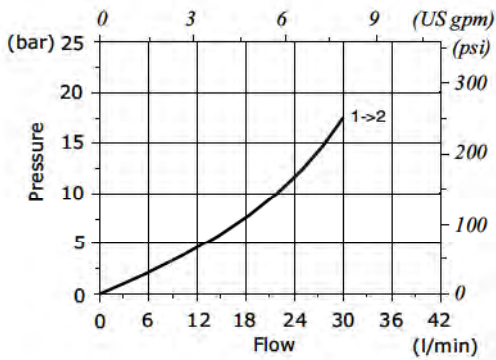

EE10A pressure drop vs. flow
- Spool 2 -

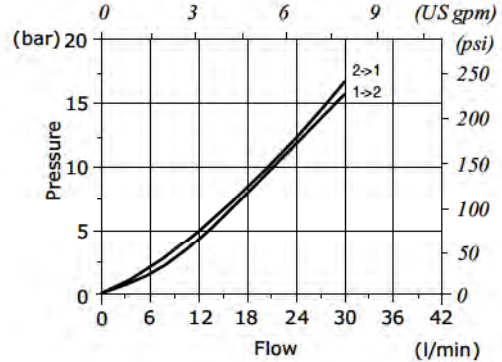

EE12A pressure drop vs. flow
- Spool 1 -

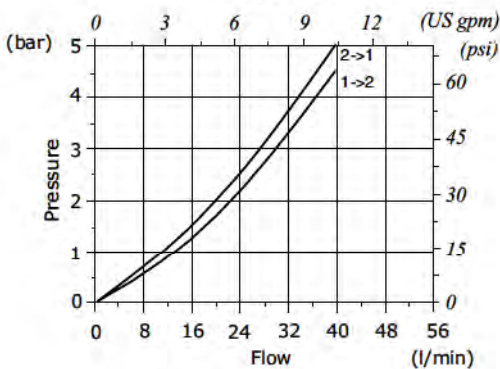

EE12A pressure drop vs. flow
- Spool 2 -

