



QUICK COUPLING M42

2020



CONTENTS

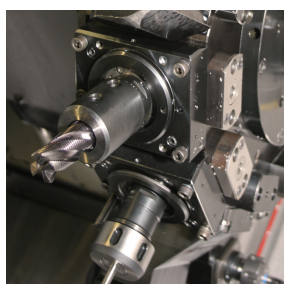
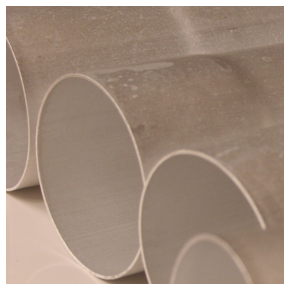

Quick coupling M42 description.....	2
Dimensional sketch.....	3
Male coupling for welding KKV	4
Female coupling for welding KKM	4
Male coupling with hose connection KVS	5
Male coupling for safety clamp KVSK	5
Female coupling with hose connection KMS	6
Female coupling for safety clamp KMSK	6
Male coupling with thread KVG, KVG(I)	7
Female coupling with thread KMG	7
Flanged male coupling KF	8
Flanged female coupling KE	8
Blind male coupling KXV	8
Blind female couplings KXM	8
Bend KRKB 90°	9
Bend KRKB 45°	9
Bend KRKB 30°	9
Twin male intermediate coupling KK2V	10
Twin female intermediate coupling KK2M	10
Enlarger KFV	10
Reducer KFK	10
T-piece KTH	11
T-piece with male thread KGT	11
Hose Menders	11
Quick coupling pipe SK	12
Safety cover.....	12
Rubber seal KKG	13
Semi - manufactures.....	13

TYKOFLEX AB • Box 614 • SE-135 26 Tyresö Sweden • Tel 00468 505 949 00
 info@tykoflex.se • www.tykoflex.com



QUICK COUPLING M42

M42 is a complete range of quick couplings for safe and speedy handling of pipes and hose systems. The couplings are produced in several dimensions and are available in galvanised steel, aluminium and stainless steel. The construction makes the couplings extremely user-friendly. It guarantees total tightness for both pressure and vacuum and can be used for anything that can be pumped, blown, pressed or sucked through pipes and hoses. All couplings and fittings are entirely manufactured at our production premises in Tyresö, Sweden.

SAFETY LOCKING DEVICE

The safety locking device prevents disconnection through e.g. vibrations and unintentional disturbance.

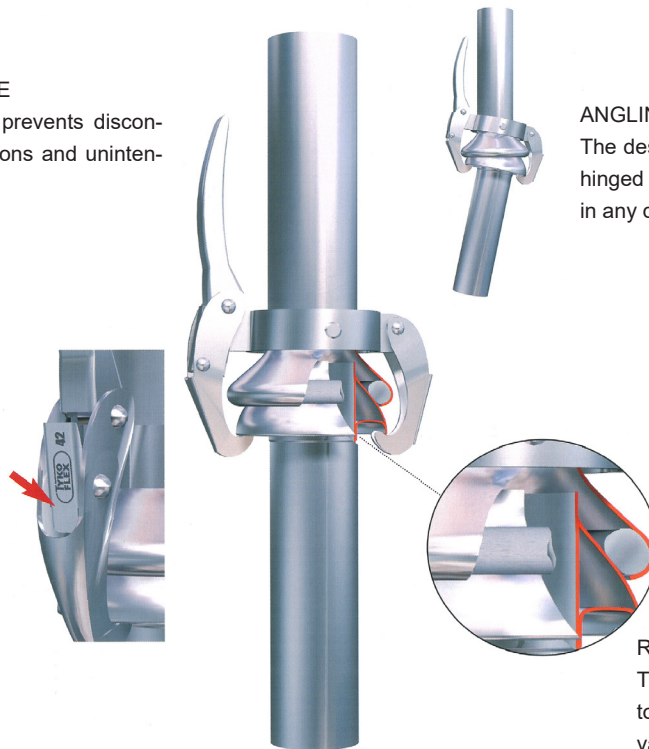

ANGLING

The design of the coupling and the hinged hook system allows angling in any direction.

RUBBER SEAL

The thick sealing ring guarantees total tightness for both pressure and vacuum. The sealing ring comes in different materials for different media and temperatures.

DIFFERENT USES FOR QUICK COUPLING M42

- » As couplings during loading and unloading stages.
- » On sewage vehicles for emptying tanks and cisterns.
- » On trucks for bulk transport of grain, flour, feed, pellets, granulates, concrete and minerals.
- » For mobile water and compressed air pipes.
- » For pump connections on both pressure and suction side.
- » For all types of irrigation systems.

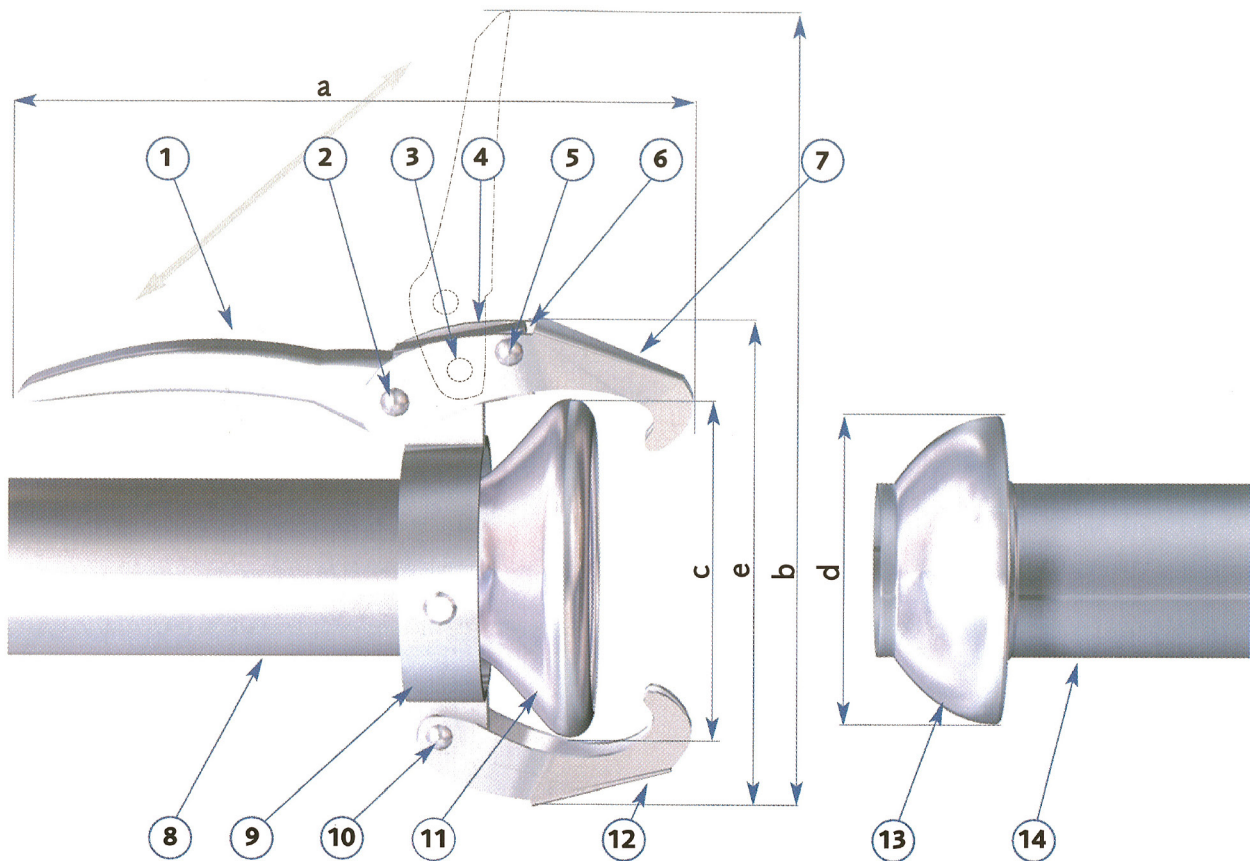

- | | |
|-------------------------|--------------------------|
| 1. Lever | 8. Pipe socket |
| 2. Rivet for over hook | 9. Ring |
| 3. Rivet for under hook | 10. Rivet for under hook |
| 4. Lock | 11. Female part |
| 5. Rivet for lock | 12. Lower hook |
| 6. Spring for lock | 13. Male part |
| 7. Upper hook | 14. Pipe socket |

Coupling size	a	b	c	d	e
38	186	230	72	67	105
48	240	295	104	100	155
60	240	305	115	109	165
76	285	360	135	129	205
102	285	380	162	158	235
133	380	490	193	179	295
152	380	530	218	200	315
204*	380	550	286	278	380

*) The female coupling is equipped with 3 levers.

The right to make changes in construction and dimension is reserved.

CHECKLIST WHEN ORDERING M42

1. Male or female coupling?
2. Coupling size? 38 (1½"), 48 (2"), 76 (3"), 102 (4"), 133 (5"), 152 (6") or 204 (8")
3. Type of connection? Hose socket, bare end for welding, male thread, flange etc.
4. Size of connection?
5. Material? Galvanized steel, black steel, stainless steel or aluminium.
6. Rubber seal if other than standard EPDM? Nitrile, viton or silicone.



KKV – Male coupling for welding

- Galvanized steel.
- Black steel.
- Aluminium.
- Stainless steel EN 1.4404 / AISI 316L.

	Galvanized steel	Black steel	Aluminium	Stainless steel		
Size	Art.no.	Art.no.	Art.no.	Art.no.	L (mm)	W (kg)
38 x 38	1621408	1621480	-	1631603	70	0,2
48 x 50	1621416	1621482	1322662	-	70	0,4
48 x 51	-	-	-	1631605	70	0,4
48 x 60	1621418	1621483	-	1631607	70	0,4
76 x 60	1621429	1621485	-	1631611	80	0,7
76 x 76	1621432	1621486	1322667	1631613	80	0,7
76 x 84	-	-	-	1631615	80	0,7
76 x 89	1621434	1621487	-	1631617	80	0,7
102 x 102	1621440	1621488	1322676	-	85	1,2
102 x 103	-	-	-	1631621	85	1,2
102 x 114	1621442	1621489	-	1631623	85	1,2
133 x 127	-	-	1322685	-	100	1,6
133 x 129	-	-	-	1631629	100	1,6
133 x 133	1621457	1621490	-	-	100	1,6
133 x 139	1621459	1621491	-	1631631	100	1,6
152 x 152	1621465	1621492	1322694	-	120	2,8
152 x 154	-	-	-	1631637	120	2,8
152 x 168	1621467	1621493	-	1631638	120	2,8
204 x 204	1621475	1621494	-	1631639	200	8,0
204 x 219	1621477	-	-	-	200	8,0



KKV – Male coupling with guide socket for welding

- Black steel. Pipe thickness 3,6 mm. Guide socket 20 mm.

	Black steel		
Size	Art.no.	L (mm)	W (kg)
102 x 3,6	1628990	100	1,9

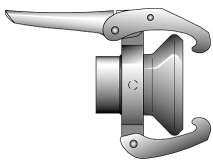

KKM – Female coupling for welding

- Galvanized steel. Lock, ring and hook-system made of galvanized steel.
- Black steel. Lock, ring and hook-system made of galvanized steel.
- Aluminium. Lock, ring and hook-system made of galvanized steel.
- Stainless steel EN 1.4404 / AISI 316L. Lock, ring and hook-system made of EN 1.4301 / AISI 304.

Standard EPDM rubber seal included

	Galvanized steel	Black steel	Aluminium	Stainless steel		
Size	Art.no.	Art.no.	Art.no.	Art.no.	L (mm)	W (kg)
38 x 38	1621507	1621580	-	1631668	125	0,4
48 x 50	1621515	1621582	1322709	-	145	1,3
48 x 51	-	-	-	1631670	145	1,3
48 x 60	1621517	1621583	-	1631672	145	1,3
76 x 60	1621528	1621585	-	1631685	165	2,5
76 x 76	1621531	1621586	1322727	1631688	165	2,5
76 x 84	-	-	-	1631690	165	2,5
76 x 89	1621533	1621587	-	1631692	165	2,6
102 x 102	1621549	1621588	1322736	-	175	3,4
102 x 103	-	-	-	1631696	175	3,4
102 x 114	1621551	1621589	-	1631697	175	3,6
133 x 127	-	-	1322745	-	215	5,7
133 x 129	-	-	-	1631698	215	5,7
133 x 133	1621556	1621590	-	-	215	5,8
133 x 139	1621558	1621591	-	1631651	215	5,8
152 x 152	1621564	1621592	1322754	-	245	8,9
152 x 154	-	-	-	1631699	245	8,9
152 x 168	1621566	1621593	-	1631658	245	8,9
204 x 204	1621575	1621594	-	1631701	250	14,0
204 x 219	1621577	-	-	-	250	14,0

 = Not in stock - delivery time 2-3 weeks.

All measurements and weights are valid for couplings made of galvanized steel.

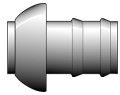

KVS – Male coupling with hose connection

- Galvanized steel.
- Aluminium.
- Stainless steel EN 1.4404 / AISI 316L.

Size	O.d. hose tail	Galvanized steel	Aluminium	Stainless steel	L (mm)	W (kg)
		Art.no.	Art.no.	Art.no.		
38 x 32	32	-	-	1631700	110	0,3
38 x 40	38	1621606	-	1631702	110	0,3
48 x 40	38	1621614	-	1631704	130	0,5
48 x 50	48	1621622	1322818	1631712	130	0,6
48 x 65	60	-	-	1631720	130	0,6
76 x 50	48	1621655	-	1631738	210	1,0
76 x 65	61	1621663	1322854	1631746	170	1,0
76 x 73,6	74	1621670	1322861	1631750	170	1,0
76 x 80	76	1621671	1322863	1631753	170	1,0
102 x 73,6	74	1621672	1322864	-	255	1,7
102 x 80	76	1621673	1322865	-	255	1,7
102 x 90	90	1621675	-	-	175	1,5
102 x 100	100	1621689	1322872	1631761	175	1,4
133 x 125	125	1621697	1322881	1631769	200	2,2
152 x 150	148	1621705	1322890	1631777	200	3,7
204 x 200	198	1621715	-	1631785	250	9,0

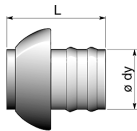

KVS – Male coupling for hose reel

- Galvanized steel.
- Stainless steel EN 1.4404 / AISI 316L.

Size	ødy (mm)	Galvanized steel	Stainless steel	L (mm)	W (kg)
		Art.no.	Art.no.		
76 x 65	61	1671019	-	140	0,9
76 x 73,6	74	1671020	1672020	125	0,9

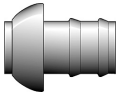

KVS – Male coupling with thick wall hose tail

- Galvanized steel. Lock, ring and hook-system made of galvanized steel.

Size	ødy (mm)	Galvanized steel	L (mm)	W (kg)
		Art.no.		
102 x 100 x 3,6	100	1671029	175	2,4
133 x 125 x 4,0	125	1671035	225	3,9

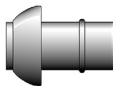

KVSK – Male coupling with hoesetail for safety clamp

- Galvanized steel.
- Stainless steel EN 1.4404 / AISI 316L.

Size	ødy (mm)	Galvanized steel	Stainless steel	L (mm)	W (kg)
		Art.no.	Art.no.		
76 x 75		1625025	1631525	225	4,6
102 x 100		1625027	1631527	290	7,9

 = Not in stock - delivery time 2-3 weeks.

All measurements and weights are valid for couplings made of galvanized steel.

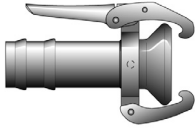

KMS – Female coupling with hose connection

- Galvanized steel. Lock, ring and hook-system made of galvanized steel.
- Aluminium. Lock, ring and hook-system made of galvanized steel.
- Stainless steel EN 1.4404 / AISI 316L. Lock, ring and hook-system made of EN 1.4301 / AISI 304.

Standard EPDM rubber seal included.

Size	O.d. hose tail	Galvanized steel	Aluminium	Stainless steel	L (mm)	W (kg)
		Art.no.	Art.no.	Art.no.		
38 x 32	32	-	-	1631800	150	0,5
38 x 40	38	1621804	-	1631801	150	0,5
48 x 40	40	1621812	-	1631803	210	1,4
48 x 50	48	1621820	1322918	1631811	210	1,4
48 x 65	60	-	-	1631829	210	1,5
76 x 50	48	1621853	-	1631837	220	2,6
76 x 65	61	1621861	1322954	1631845	260	2,6
76 x 73,6	74	1621878	1322961	1631849	260	2,7
76 x 80	76	1621879	1322963	1631852	260	2,8
102 x 73,6	74	1621880	-	-	260	3,5
102 x 80	76	1621881	1322965	-	260	3,6
102 x 90	90	1621883	-	-	270	3,6
102 x 100	100	1621887	1322972	1631860	270	3,6
133 x 125	125	1621895	1322981	1631868	320	6,4
152 x 150	148	1621903	1322990	1631876	330	9,5
204 x 200	198	1621915	-	1631884	340	15,0

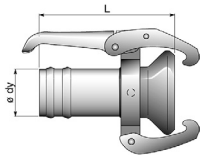

KMS – Female coupling for hose reel

- Galvanized steel. Lock, ring and hook-system made of galvanized steel.
- Stainless steel EN 1.4404 / AISI 316L. Lock, ring and hook-system made of EN 1.4301 / AISI 304.

Standard EPDM rubber seal included.

Size	ødy (mm)	Galvanized steel	Stainless steel	L (mm)	W (kg)
		Art.no.	Art.no.		
76 x 65	61	1671119	-	185	2,5
76 x 73,6	74	1671120	1672120	170	2,5

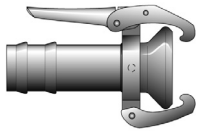

KMS – Female coupling with thick wall hose tail

- Galvanized steel. Lock, ring and hook-system made of galvanized steel.

Standard EPDM rubber seal included.

Size	ødy (mm)	Galvanized steel	L (mm)	W (kg)
		Art.no.		
102 x 100 x 3,6	100	1671129	225	4,6
133 x 125 x 4,0	125	1671135	290	7,9

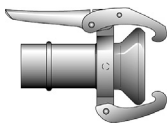

KMSK – Female coupling with hoesetail for safety clamp

- Galvanized steel. Lock, ring and hook-system made of galvanized steel.
- Stainless steel EN 1.4404 / AISI 316L. Lock, ring and hook-system made of EN 1.4301 / AISI 304.

Standard EPDM rubber seal included.

Size	ødy (mm)	Galvanized steel	Stainless steel	L (mm)	W (kg)
		Art.no.	Art.no.		
76 x 75		1625010	1631510		2,6
102 x 100		1625015	1631515		3,7

 = Not in stock - delivery time 2-3 weeks.

All measurements and weights are valid for couplings made of galvanized steel.

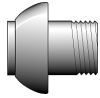

KVG – Male coupling with male thread B.S.P.

- Galvanized steel.
- Aluminium.
- Stainless steel EN 1.4404 / AISI 316L.

Size	Galvanized steel Art.no.	Aluminium Art.no.	Stainless steel Art.no.	L (mm)	W (kg)
38 x R32	1621000	-	1631403	105	0,4
38 x R40	1621002	-	1631405	120	0,4
48 x R40	1621010	1322409	1631407	100	0,7
48 x R50	1621028	1322418	1631415	100	0,7
76 x R50	1621051	1322436	1631423	125	1,4
76 x R65	1621069	1322445	1631431	105	1,1
76 x R80	1621077	1322454	1631449	105	1,2
102 x R80	1621081	1322461	1631456	135	1,5
102 x R100	1621085	1322463	1631458	125	1,9
133 x R125	1621093	-	1631461	155	2,3
152 x R150	1621101	-	1631470	175	3,6

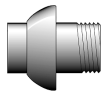

KVG – Male coupling with guide socket and male thread B.S.P.

- Galvanized steel.

Size	Galvanized steel Art.no.	Aluminium Art.no.	Stainless steel Art.no.	L (mm)	W (kg)
48 x R50	1621027	-	-	145	0,7
76 x R80	1621076	-	-	155	1,2
102 x R100	1621084	-	-	170	1,6



KVG(I) – Male coupling with female thread B.S.P.

- Electro zinc plated steel.
- Stainless steel EN 1.4404 / AISI 316L.

Size	Galvanized steel Art.no.	Aluminium Art.no.	Stainless steel Art.no.	L (mm)	W (kg)
76 x G80	1621078	-	-	115	1,1
102 x G100	1621086	-	1631459	125	1,8

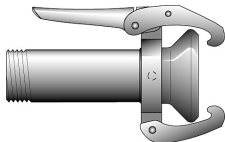

KMG – Female coupling with male thread B.S.P.

- Galvanized steel. Lock, ring and hook-system made of galvanized steel.
- Aluminium. Lock, ring and hook-system made of galvanized steel.
- Stainless steel EN 1.4404 / AISI 316L. Lock, ring and hook-system made of EN 1.4301 / AISI 304.

Standard EPDM rubber seal included.

Size	Galvanized steel Art.no.	Aluminium Art.no.	Stainless steel Art.no.	L (mm)	W (kg)
38 x R32	1621194	-	1631502	170	0,6
38 x R40	1621200	-	1631504	170	0,7
48 x R40	1621218	1322509	1631506	260	1,5
48 x R50	1621226	1322518	1631514	260	1,5
76 x R50	1621259	1322536	1631522	305	3,0
76 x R65	1621267	1322545	1631530	305	3,0
76 x R80	1621275	1322554	1631548	305	3,1
102 x R80	1621279	1322561	1631554	320	4,0
102 x R100	1621283	1322563	1631556	320	4,1
133 x R125	1621291	1322567	1631562	375	7,1
152 x R100	-	1322576	-	375	-
152 x R150	1621309	-	1631570	375	10,6

■ = Not in stock - delivery time 2-3 weeks.

All measurements and weights are valid for couplings made of galvanized steel.



KF – Flanged male coupling

- Galvanized steel. Flange DIN PN10/16
- Stainless steel EN 1.4404 / AISI 316L. Flange of EN 1.4404 / AISI 316L, DIN PN 10/16
- Stainless steel EN 1.4404 / AISI 316L. Flange of silumin DIN PN10.

	Galvanized steel	Stainless steel	Stainless steel/silumin		
Size	Art.no.	Art.no.	Art.no.	L (mm)	W (kg)
48 x DN40	1622018	1632009	1631902	105	2,2
48 x DN50	1622026	1632017	1631910	105	2,9
76 x DN50	1622059	1632025	1631928	120	3,3
76 x DN65	1622067	1632033	1631936	120	3,7
76 x DN80	1622075	1632041	1631944	120	4,4
102 x DN100	1622083	1632058	1631951	135	5,5
133 x DN125	1622091	1632066	1631958	145	7,5
152 x DN150	1622109	1632074	1631966	145	10,0
204 x DN200 PN10	1622120	1632082	-	200	20,0

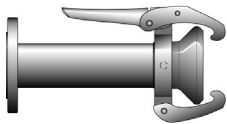

KE – Flanged female coupling

- Galvanized steel. Lock, ring and hook-system made of galvanized steel. Flange DIN PN10/16
- Stainless steel EN 1.4404 / AISI 316L. Lock, ring and hook-system made of EN 1.4301 / AISI 304. Flange of EN 1.4404 / AISI 316L, DIN PN 10/16
- Stainless steel EN 1.4404 / AISI 316L. Lock, ring and hook-system made of EN 1.4301 / AISI 304. Flange of silumin DIN PN10

Standard EPDM rubber seal included.

	Galvanized steel	Stainless steel	Stainless steel/silumin		
Size	Art.no.	Art.no.	Art.no.	L (mm)	W (kg)
48 x DN40	1622216	1630805	-	295	3,5
48 x DN50	1622224	1630813	1630714	290	4,1
76 x DN50	1622257	1630821	1630730	310	5,2
76 x DN65	1622265	1630839	1630748	310	6,5
76 x DN80	1622273	1630847	1630755	310	7,0
102 x DN100	1622281	1630854	1630763	325	8,2
133 x DN125	1622299	1630862	-	410	14,0
152 x DN150	1622307	1630870	1630779	410	17,0
204 x DN200 PN10	1622320	1630878	-	500	25,0



KXV – Blind male coupling

- Galvanized steel.
- Stainless steel EN 1.4404 / AISI 316L.

	Galvanized steel	Stainless steel		
Size	Art.no.	Art.no.	L (mm)	W (kg)
38	-	1630902	30	0,2
48	1622414	1630904	37	0,3
76	1622430	1630912	50	0,5
102	1622448	1630920	45	0,7
133	1622455	1630928	50	1,1
152	1622463	1630936	65	1,8
204	1622475	1630944	110	6,6



KXM – Blind female coupling

- Galvanized steel. Lock, ring and hook-system made of galvanized steel.
- Stainless steel EN 1.4404 / AISI 316L. Lock, ring and hook-system made of EN 1.4301 / AISI 304.

Standard EPDM rubber seal included.

	Galvanized steel	Stainless steel		
Size	Art.no.	Art.no.	L (mm)	W (kg)
38	-	1630977	60	0,4
48	1622513	1630979	80	1,2
76	1622539	1630987	90	2,3
102	1622547	1630995	95	3,2
133	1622554	1630997	120	5,5
152	1622562	1630999	130	8,0
204	1622575	1631000	120	12,9

 = Not in stock - delivery time 2-3 weeks.

All measurements and weights are valid for couplings made of galvanized steel.

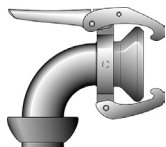

KRKB – Bend 90°

- Galvanized steel. Lock, ring and hook-system made of galvanized steel.
- Aluminium. Lock, ring and hook-system made of galvanized steel.
- Stainless steel EN 1.4404 / AISI 316L. Lock, ring and hook-system made of EN 1.4301 / AISI 304.

Standard EPDM rubber seal included.

Size	Galvanized steel	Aluminium	Stainless steel	W (kg)
	Art.no.	Art.no.	Art.no.	
38	1622901	-	-	1,0
48	1622919	1325000	1631100	2,0
76	1622935	1325002	1631118	3,7
102	1622943	1325003	1631126	6,1
133	1622950	1325004	1631134	11,5
152	1622968	1325005	1631142	20,0



KRKB – Bend 45°

- Galvanized steel. Lock, ring and hook-system made of galvanized steel.
- Aluminium. Lock, ring and hook-system made of galvanized steel.
- Stainless steel EN 1.4404 / AISI 316L. Lock, ring and hook-system made of EN 1.4301 / AISI 304.

Standard EPDM rubber seal included.

Size	Galvanized steel	Aluminium	Stainless steel
	Art.no.	Art.no.	Art.no.
38	1623206	-	-
48	1623214	1325010	1631175
76	1623230	1325012	1631183
102	1623248	1325013	1631191
133	1623255	1325014	1631195
152	1623263	1325015	1631199

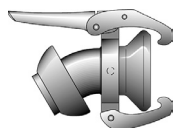

KRKB – Bend 30°

- Galvanized steel. Lock, ring and hook-system made of galvanized steel.
- Aluminium. Lock, ring and hook-system made of galvanized steel.
- Stainless steel EN 1.4404 / AISI 316L. Lock, ring and hook-system made of EN 1.4301 / AISI 304.

Standard EPDM rubber seal included.

Size	Galvanized steel	Aluminium	Stainless steel
	Art.no.	Art.no.	Art.no.
38	1623305	-	-
48	1623313	-	1631209
76	1623339	1325052	1631217
102	1623347	1325053	1631225
133	1623354	1325054	1631235
152	1623362	1325055	1631241

 = Not in stock - delivery time 2-3 weeks.

All measurements and weights are valid for couplings made of galvanized steel.

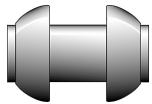

KK2V – Twin male intermediate coupling

- Galvanized steel.
- Aluminium.
- Stainless steel EN 1.4404 / AISI 316L.

Galvanized steel

Stainless steel

Size	Art.no.	Art.no.	L (mm)	W (kg)
38	1622604	-	120	0,4
48	1622612	1631001	150	0,9
76	1622638	1631019	170	1,5
102	1622646	1631027	180	2,4
133	1622653	1631036	190	3,1
152	1622661	1631045	230	5,0

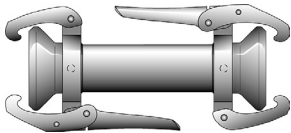

KK2M – Twin female intermediate coupling

- Galvanized steel. Lock, ring and hook-system made of galvanized steel.
- Aluminium. Lock, ring and hook-system made of galvanized steel.
- Stainless steel EN 1.4404 / AISI 316L. Lock, ring and hook-system made of EN 1.4301 / AISI 304.

Standard EPDM rubber seal included.

Galvanized steel

Stainless steel

Size	Art.no.	Art.no.	L (mm)	W (kg)
38	1622703	-	230	1,5
48	1622711	1631076	310	2,7
76	1622737	1631084	370	5,0
102	1622745	1631092	380	6,9
133	1622752	1631095	550	12,0
152	1622760	1631098	500	18,3

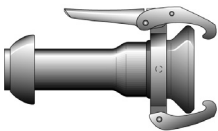

KFV – Enlarger male x female

- Galvanized steel. Lock, ring and hook-system made of galvanized steel.
- Aluminium. Lock, ring and hook-system made of galvanized steel.
- Stainless steel EN 1.4404 / AISI 316L. Lock, ring and hook-system made of EN 1.4301 / AISI 304.

Standard EPDM rubber seal included.

Size male x female	Galvanized steel Art.no.	Aluminium Art.no.	Stainless steel Art.no.	L (mm)	W (kg)
38 x 48	1623703	-	-	290	1,0
48 x 60	1623729	-	-	320	2,2
48 x 76	1623745	1325701	1631302	340	3,2
60 x 76	1623752	-	-	330	3,5
76 x 102	1624360	1325704	1631304	340	4,4
76 x 133	1623805	-	-	450	7,1
102 x 133	1623810	1325707	-	450	7,4
102 x 152	1623836	1325708	1631306	455	10,0
133 x 152	1623844	1325709	-	425	10,5

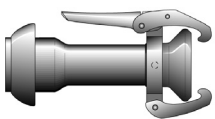

KFK – Reducer male x female

- Galvanized steel. Lock, ring and hook-system made of galvanized steel.
- Aluminium. Lock, ring and hook-system made of galvanized steel.
- Stainless steel EN 1.4404 / AISI 316L. Lock, ring and hook-system made of EN 1.4301 / AISI 304.

Standard EPDM rubber seal included.

Size male x female	Galvanized steel Art.no.	Aluminium Art.no.	Stainless steel Art.no.	L (mm)	W (kg)
48 x 38	1623503	-	-	290	1,0
60 x 48	1623529	-	1631280	305	2,0
76 x 48	1623545	1325601	1631282	335	2,5
76 x 60	1623552	-	1631284	345	2,5
102 x 48	-	1325603	-	-	-
102 x 60	1623578	-	-	335	3,9
102 x 76	1623586	1325605	1631290	340	3,9
133 x 76	1623605	-	1631292	360	5,6
133 x 102	1623610	1325606	1631294	360	6,5
152 x 102	1623636	1325607	1631296	465	6,9
152 x 133	1623644	1325608	1631298	455	10,0

 = Not in stock - delivery time 2-3 weeks.

All measurements and weights are valid for couplings made of galvanized steel.

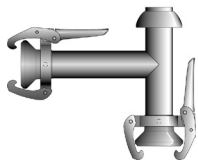

KTH – T-piece

- Galvanized steel. Lock, ring and hook-system made of galvanized steel.
- Aluminium. Lock, ring and hook-system made of galvanized steel.
- Stainless steel EN 1.4404 / AISI 316L. Lock, ring and hook-system made of EN 1.4301 / AISI 304.

Standard EPDM rubber seal included.

	Galvanized steel	Aluminium	Stainless steel
Size	Art.no.	Art.no.	Art.no.
48 x 38	1624105	-	-
48 x 48	1624014	1325100	1631308
76 x 48	1624147	1325106	1631324
76 x 76	1624030	1325102	1631316
102 x 48	1624170	1325107	1631357
102 x 76	1624196	1325108	1631340
102 x 102	1624048	1325103	1631332
133(127) x 48	-	1325109	-
133(127) x 76	1624220	1325110	-
133(127) x 102	1624238	1325111	-
133(127) x 133(127)	1624055	1325104	-
152 x 76	-	1325113	-
152 x 102	1624279	-	-
152 x 133(127)	1624287	-	-
152 x 152	1624063	1325105	-

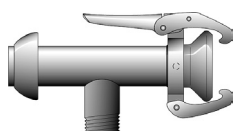

KGT – T-piece with male thread B.S.P.

- Galvanized steel. Lock, ring and hook-system made of galvanized steel.
- Aluminium. Lock, ring and hook-system made of galvanized steel.
- Stainless steel EN 1.4404 / AISI 316L. Lock, ring and hook-system made of EN 1.4301 / AISI 304.

Standard EPDM rubber seal included.

	Galvanized steel	Aluminium	Stainless steel
Size	Art.no.	Art.no.	Art.no.
48 x R25	1624618	-	-
48 x R40	1624626	1325400	-
48 x R50	-	-	1631373
76 x R25	1624667	-	-
76 x R40	-	1325403	-
76 x R50	-	1325404	-
76 x R65	1624691	1325401	1631381
76 x R80	1624535	-	-
102 x R25	1624709	-	-
102 x R40	-	1325405	-
102 x R50	-	1325406	-
102 x R65	-	1325407	-
102 x R80	1624720	1325408	1631399
102 x R100	1624543	-	-
133(127) x R80	-	1325411	-
133(127) x R100	1624730	1325412	-
152 x R50	-	1325413	-
152 x R80	-	1325415	-
152 x R100	1624740	1325416	-

Hose Menders in Aluminium



DN	Art.no.	L (mm)
40	1600040	140
50	1600050	140
65	1600065	150
80	1600080	150
100	1600100	160
125	1600125	180
150	1600150	200

 = Not in stock - delivery time 2-3 weeks.

All measurements and weights are valid for couplings made of galvanized steel.



Quick coupling pipe – Galvanized steel

SK-pipe 48 - $\varnothing 50 \times 1,3$ - coupling size 48
 SK-pipe 76 - $\varnothing 76 \times 1,5$ - coupling size 76
 SK-pipe 102 - $\varnothing 102 \times 1,7$ - coupling size 102
 SK-pipe 133 - $\varnothing 127 \times 1,8$ - coupling size 133
 SK-pipe 152 - $\varnothing 152,4 \times 2,0$ - coupling size 152

- Galvanized steel. Lock, ring and hook-system made of galvanized steel.

Standard EPDM rubber seal included.

Pipe length metre	SK-pipe 48		SK-pipe 76		SK-pipe 102	
	Art.no.	W (kg)	Art.no.	W (kg)	Art.no.	W (kg)
1	1620616	3,4	1620632	5,9	1620640	9,1
2	1620517	5,2	1620533	8,8	1620541	13,7
3	1620418	7,0	1620434	11,7	1620442	18,3
4	1620319	8,8	1620335	14,6	1620343	22,9
5	1620210	10,6	1620236	17,5	1620244	27,5
6	1620111	12,4	1620137	20,4	1620145	32,1

Pipe length metre	SK-pipe 133		SK-pipe 152	
	Art.no.	W (kg)	Art.no.	W (kg)
1	1620657	15,2	1620665	20,7
2	1620558	23,2	1620566	30,2
3	1620459	31,2	1620467	39,7
4	1620350	39,2	1620368	49,2
5	1620251	47,2	1620269	58,7
6	1620152	55,2	1620160	68,2



Quick coupling pipe – Aluminium

SK-pipe 48 - $\varnothing 50 \times 1,3$ - coupling size 48
 SK-pipe 76 - $\varnothing 76 \times 1,5$ - coupling size 76
 SK-pipe 102 - $\varnothing 102 \times 1,7$ - coupling size 102
 SK-pipe 133 - $\varnothing 127 \times 1,8$ - coupling size 133
 SK-pipe 152 - $\varnothing 152,4 \times 2,0$ - coupling size 152

- Aluminium SS 14 4212-06. Lock, ring and hook-system made of galvanized steel.

Standard EPDM rubber seal included.

Pipe length metre	SK-pipe 48		SK-pipe 76		SK-pipe 102	
	Art.no.	W (kg)	Art.no.	W (kg)	Art.no.	W (kg)
1	1320404	1,4	1320003	3,2	1320102	4,4
2	1320414	2,0	1320011	4,3	1320110	6,1
3	1320424	2,6	1320029	5,4	1320128	7,8
4	1320434	3,2	1320037	6,5	1320136	9,5
5	1320444	4,0	1320045	7,6	1320144	11,2
6	1320454	4,6	1320052	8,7	1320151	12,9

Pipe length metre	SK-pipe 133		SK-pipe 152	
	Art.no.	W (kg)	Art.no.	W (kg)
1	1320201	7,0	1320300	8,2
2	1320219	9,4	1320318	11,2
3	1320227	11,8	1320326	14,2
4	1320235	14,2	1320334	17,2
5	1320243	16,6	1320342	20,2
6	1320250	19,0	1320359	23,2



Safety cover

Safety cover for couplings size 76 and 102 made of stainless steel including padlock and chain. The cover is mounted on the lever and upper hook in order to prevent unintentional connections or vandalism.

Designation	Art.no.
Safety cover 76/102 incl. chain and padlock	1638010
Safety cover 76/102 incl. chain	1638012

 = Not in stock - delivery time 2-3 weeks.

All measurements and weights are valid for couplings made of galvanized steel.

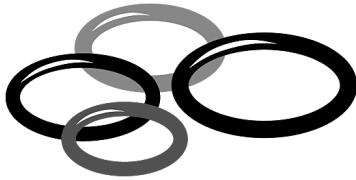

KKG - Rubber seal for coupling Model 42

EPDM (grey) For temperatures from +120° to -50°C. Good weather- and ozone resistance. Suitable for water and air. Resistant to vegetable oils.

Nitrile (black) For temperatures from +100° to -40°C. Oil resistant to mineral oils and petrol.

Viton (FPM) (black) for temperatures from +250° to -30°C. Resistant to petrol, mineral oils and most chemicals even at high temperatures. Not suitable for ketones and lacquers solvents.

Silicone (translucent) For temperatures from +250° to -70°C. Good weather- and ozone resistance.

Size	EPDM Art.no.	Nitrile Art.no.	Viton Art.no.	Silicone Art.no.	Dim. (mm) Dy x Di x t
38	1626407	1626605	1626928	-	70 x 54 x 8
48	1626415	1626613	1626936	1626993	100 x 72 x 14
60	1626423	1626621	1626944	-	112 x 82 x 15
76	1626431	1626639	1626951	1626995	130 x 100 x 15
102	1626449	1626647	1626969	1626997	162 x 126 x 18
133	1626456	1626654	1626977	-	189 x 145 x 22
152	1626464	1626662	1626985	-	215 x 171 x 20
204	-	1626672	-	-	275 x 245 x 15



Male coupling – Semi-manufacture

- Black steel.
- Aluminium.
- Stainless steel EN 1.4404 / AISI 316L.

Size	Black steel Art.no.	Aluminium Art.no.	Stainless steel Art.no.
38	1626105	-	1632103
48	1626110	1324209	1632105
76	1626120	1324227	1632110
102	1626125	1324236	1632115
133	1626130	1324245	1632120
152	1626135	1324254	1632125
204	1626140	-	1632126

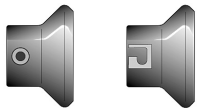

Female coupling – Semi-manufacture

- Black steel.
- Aluminium.
- Stainless steel EN 1.4404 / AISI 316L.

Excl. lock, ring, hook-system and rubber seal.

Size	Black steel Art.no.	Aluminium Art.no.	Stainless steel Art.no.
38	1626210	-	1632203
48	1626215	1324309	1632205
76	1626225	1324327	1632215
102	1626230	1324336	1632220
133	1626235	1324345	1632225
152	1626240	1324354	1632230
204	1626250	-	1632235

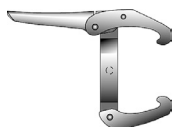

Ring with hook-system and lock

- Ring made of black steel, lock and hook-system made of galvanized steel.
- Lock, ring and hook-system made of EN 1.4301 / AISI 304.

Size	Galvanized steel Art.no.	Stainless steel Art.no.
38	1626305	1632303
48	1626310	1632305
76	1626320	1632310
102	1626325	1632315
133	1626330	1632320
152	1626335	1632325
204	1626340	1632330



CERTIFICATE

This is to certify that

Tykoflex AB

556692-9344

Tyresö, Sweden

has established and applied a management system according to

ISO 9001:2015

ISO 14001:2015

regarding

**Design, development, manufacturing and sale of joint closures
for optical fibre and copper cables as well as
quick couplings for pipes and hoses.**

The certificate is valid provided that Qvalify AB:s certification rules are fulfilled.

Jönköping 2018-02-28

Carina Björnsell

On behalf of Qvalify AB

Certificates of Origin issued:

ISO 9001 1997-02-19

ISO 14001 2009-02-16



Cert no. 1191

Valid until 2021-02-28

www.qvalify.se

